

Kabin Ölçüleri Cabinet Dimensions

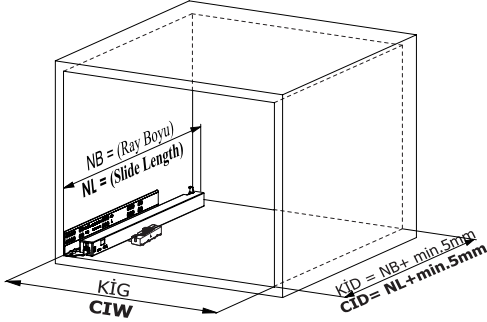

Kabin İç Geniřliđi	: KIĞ	Cabinet Internal Width	: CIW
Kabin İç Derinliđi	: KİD	Cabinet Internal Depth	: CID
Çekmece Derinliđi	: ÇD	Drawer Depth	: DD
Çekmece İç Geniřliđi	: ÇİĞ	Drawer Internal Width	: DIW
Nominal Boy (Ray boyu):	NB	Nominal Length	: NL

Tavsiye Edilen Vida ve Şablonlar Recommended Screw and Templates

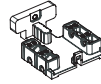
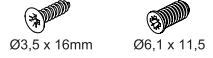

Smart Slide Mandal ve
Tırnak Deliđi Delme Şablonu
Smart Lock Template

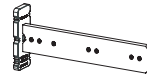

Smart El Tipi Ray
Montaj Şablonu
Smart Drilling Jig

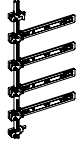

Smart Cetveli Ray
Montaj Şablonu
Smart Drilling Jig with Ruler

Rayların Vida Konum Ölçüleri Screw Location for the Slides

Rayı, koyu renk ile işaretlenmiş deliklerden vidalayınız.
Screw the slide from marked holes.

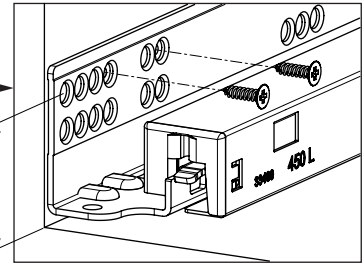
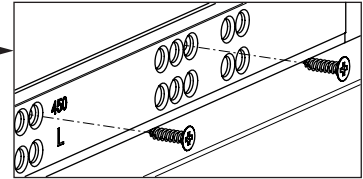
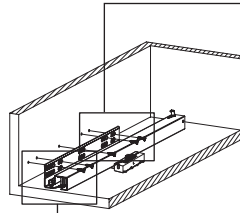
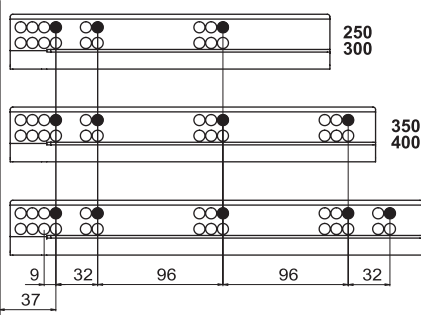

Çekmece Ölçüleri Drawer Dimensions

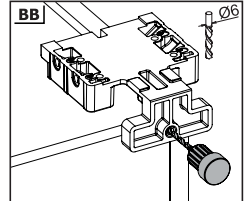
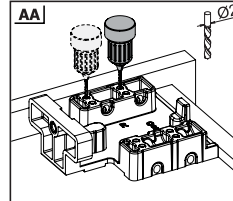
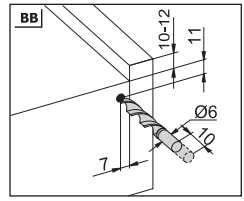
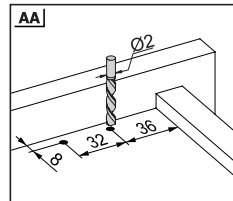
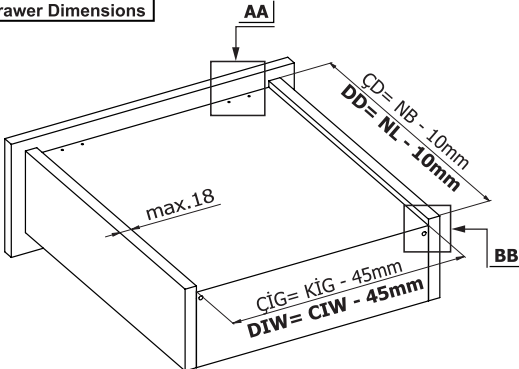

1

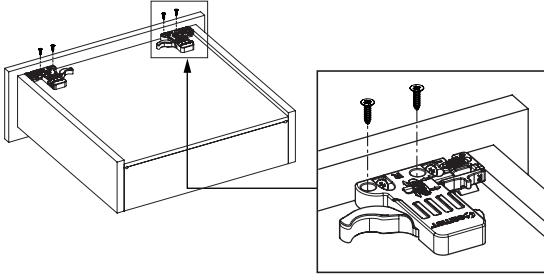

Not: Çekmece taban kalınlığı 12 mm'den küçük olduğunda, açılı mandal bağlama deliklerini kullanınız.

Note: Use angled holes to mount smart lock when wooden floor width is selected less than 12 mm.

AA

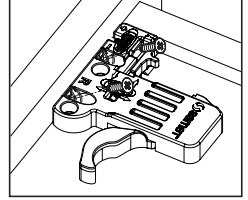
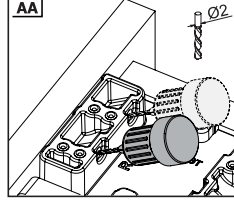

2

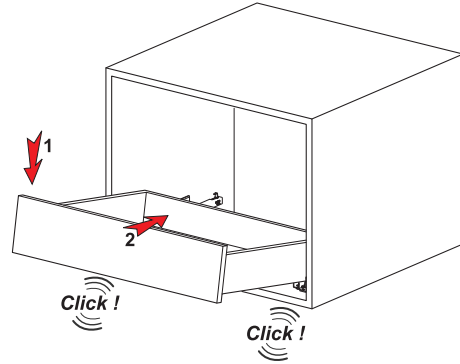

3

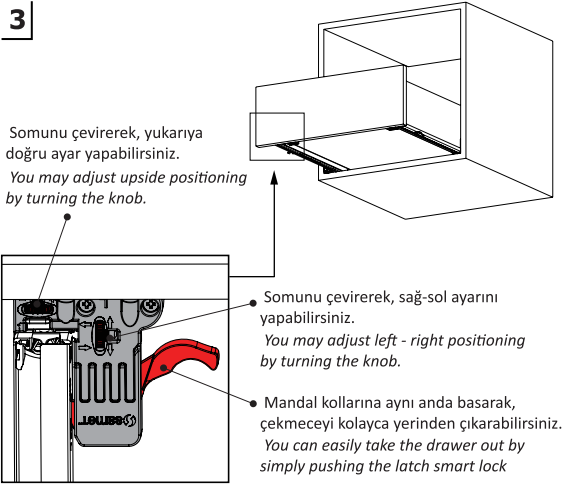

Smart El Tipi Ray
Montaj Şablonu
Smart Drilling Jig

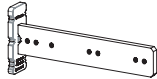

Kod / Code

12799902

12799904

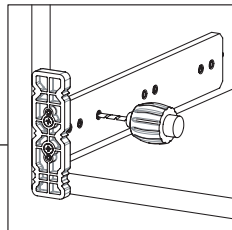
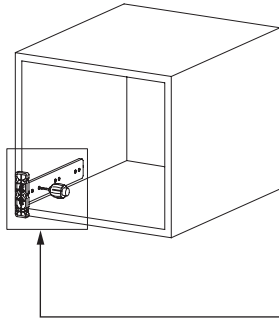

Smart Cetveli Ray
Montaj Şablonu
Smart Drilling Jig with Ruler

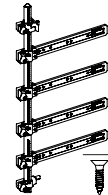

Kod / Code

12799901

12799905

